

FOR OFFICIAL USE



National
Qualifications
2018

Mark

X823/75/01

Engineering Science

THURSDAY, 24 MAY

1:00 PM – 2:50 PM



* X 8 2 3 7 5 0 1 *

Fill in these boxes and read what is printed below.

Full name of centre

Town

Forename(s)

Surname

Number of seat

Date of birth

Day

Month

Year

Scottish candidate number

Total marks — 110

SECTION 1 — 20 marks

Attempt ALL questions.

SECTION 2 — 90 marks

Attempt ALL questions.

Show all working and units where appropriate.

You should refer to the National 4/5 Engineering Science Data Booklet which you have been given.

The number of significant figures expressed in a final answer should be equivalent to the least significant data value given in the question. Answers that have two more figures or one less figure than this will be accepted.

Write your answers clearly in the spaces provided in this booklet. Additional space for answers is provided at the end of this booklet. If you use this space you must clearly identify the question number you are attempting.

Use **blue** or **black** ink.

Before leaving the examination room you must give this booklet to the Invigilator; if you do not, you may lose all the marks for this paper.



* X 8 2 3 7 5 0 1 0 1 *

SECTION 1 — 20 marks

Attempt ALL questions

1. A team of engineers is designing a kitchen blender.



- (a) State the type of engineer that would calculate the size of the gears to be used in the kitchen blender.

1

- (b) State the type of engineer that would simulate the speed control circuit in the kitchen blender.

1

2. An electronic circuit is being designed to meet the following specification:

- V_{in} should increase as the light level detected increases.

Complete the circuit diagram below to include an LDR and a fixed resistor so that the circuit meets the required specification.

3

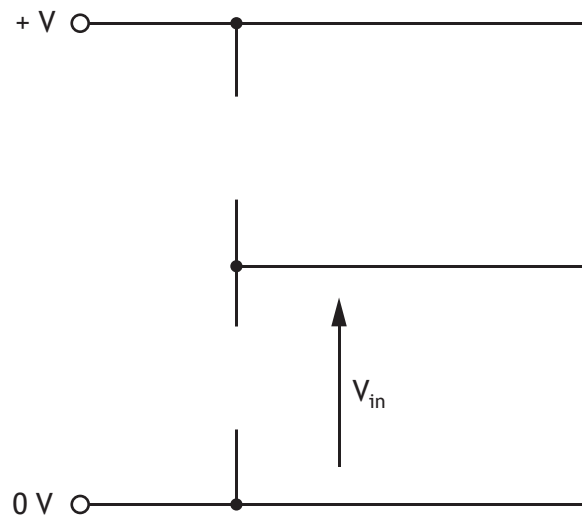

* X 8 2 3 7 5 0 1 0 2 *

3. A bike and carrier are shown below. Each bike wheel applies a force of 15 N onto the carrier.



Draw a free body diagram for the bike and carrier shown above.

2



* X 8 2 3 7 5 0 1 0 3 *

4. A motorway speed camera is designed to photograph any car that is being driven above a set speed limit.

The sub-system diagram used to represent the control of the motorway speed camera is shown.

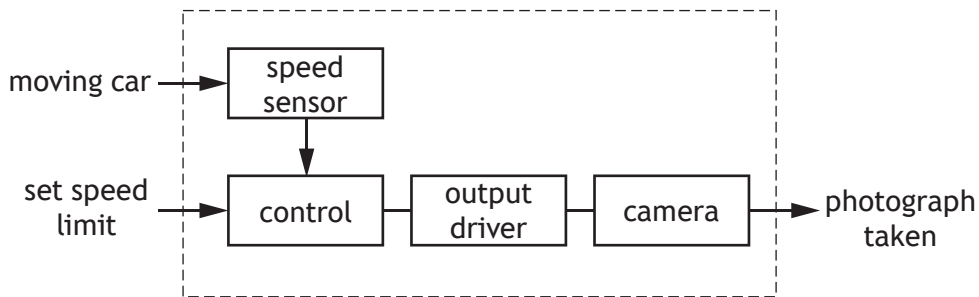

- (a) State the type of control shown in this sub-system diagram.

1

- (b) Describe the operation of the motorway speed camera.

3

The speed limit is set.

5. A buzzer is a commonly used electronic component.

Draw the symbol for a buzzer.

1



* X 8 2 3 7 5 0 1 0 4 *

6. Two beams with applied forces (F) are shown below.

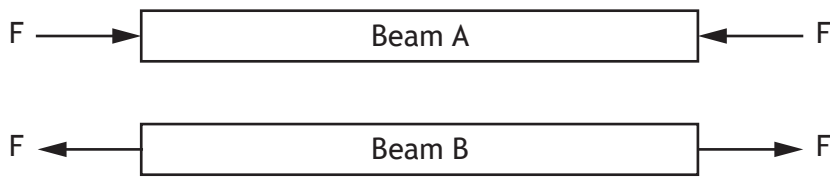

State the nature of the force acting on:

2

Beam A _____

Beam B _____

7. Complete the pneumatic symbol shown below for a 3/2 solenoid spring return valve.

1

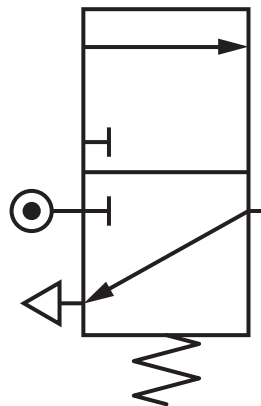

[Turn over



8. The simple gear train, shown below, has been drawn using incorrect conventions.

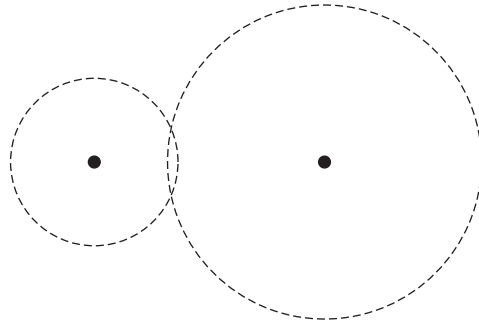

Describe two errors that were made when drawing this simple gear train.

2

Error 1 _____

Error 2 _____

9. Draw the logic diagram for the Boolean equation shown below.

3

$$Z = (\bar{A} + B) \cdot C$$

A ◦

B ◦

◦ Z

C ◦



[Turn over for next question

DO NOT WRITE ON THIS PAGE



* X 8 2 3 7 5 0 1 0 7 *

SECTION 2 — 90 marks

Attempt ALL questions

DO NOT
WRITE IN
THIS
MARGIN

10. A ball firing machine used by tennis players to practise is shown below.

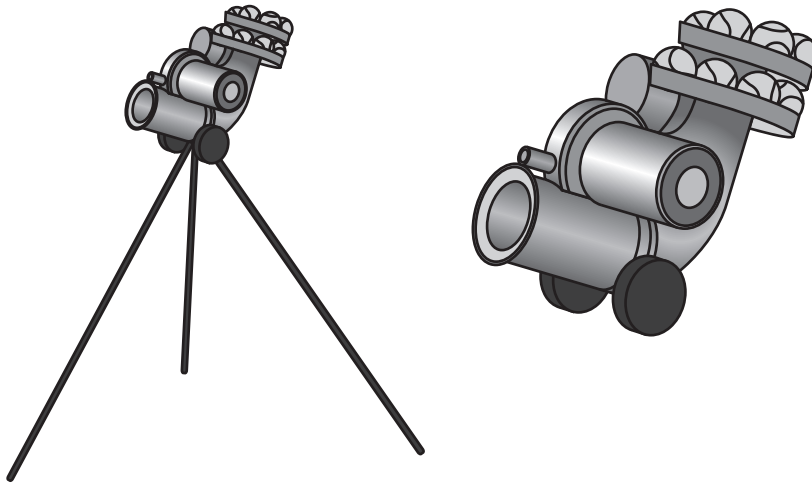

The machine is operated by a microcontroller. Input and output connections to the microcontroller are shown in the table below.

Input connections	Pin	Output connections
	7	ball firing motor
	6	red light
	5	green light
	4	ball release
start button	0	

The machine operates using the following sequence.

1. When the start button is pressed the ball firing motor starts and the red light switches on.
2. There is a 5 second delay after which the red light switches off and the green light switches on.
3. The ball release is then switched on for 0.5 seconds.
4. The ball release is then switched off for 2 seconds.
5. Steps 3 and 4 are then repeated ten times.
6. The ball firing motor and green LED then switch off and the system resets ready to be used again.



* X 8 2 3 7 5 0 1 0 8 *

MARKS

DO NOT
WRITE IN
THIS
MARGIN

10. (continued)

- (a) Complete the flowchart for the sequence, with reference to the Data Booklet and input/output connections. Include **all** pin numbers and delay units in your flowchart.

10

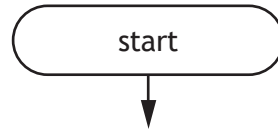

10. (continued)

During the design stage, the strain acting on the machine was analysed. It was found that when the machine was fully loaded with tennis balls, one leg had a strain of 0.0016.

- (b) Calculate the change in length of this leg when its original length was 1200 mm.

3



* X 8 2 3 7 5 0 1 1 0 *

11. A circus acrobat on a trapeze swing is suspended high above the ground. The motion of the trapeze swing is shown below.



(a) State the type of motion shown.

1

(b) The acrobat and trapeze swing have a combined mass of 69 kg.

For the acrobat and trapeze swing:

(i) calculate their potential energy when they are 6.8 m above the ground;

2

[Turn over

11. (b) (continued)

(ii) calculate their velocity when their kinetic energy is 970 J.

3

(c) Part of the supporting structure for the trapeze swing is shown below.

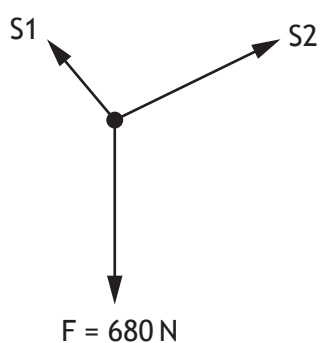

(i) State, with reference to the Data Booklet, the condition of equilibrium which does not need to be considered when studying forces acting at a single point.

1

11. (c) (continued)

- (ii) Determine the size of force S_2 using the scale drawing of the triangle of forces shown below.

1

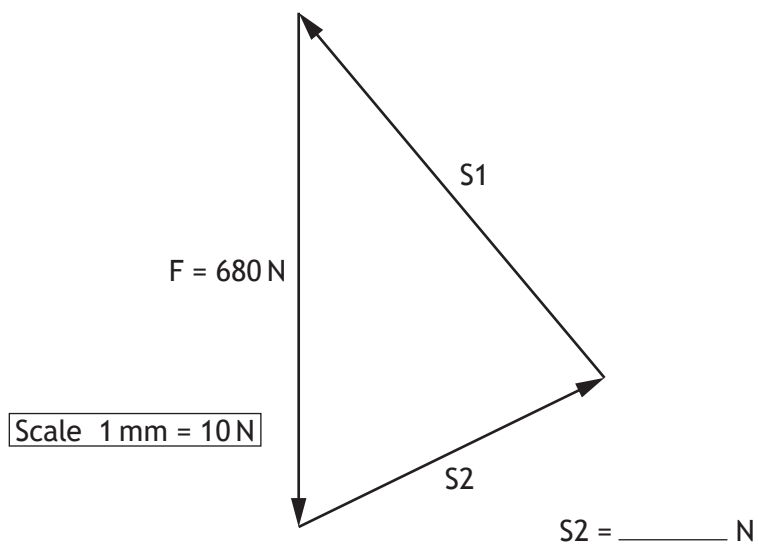

[Turn over



* X 8 2 3 7 5 0 1 1 3 *

11. (continued)

- (d) A maximum of two acrobats can hang from the trapeze swing at any one time. When this happens the forces in support wires S1 and S2 are as follows:

$$S1 = 1300N \quad S2 = 930N$$

The table below shows materials that were considered for the support wires.

	Material A	Material B	Material C	Material D
Maximum tensile load	1000 N	1300 N	3250 N	4500 N
Durability	High	Low	High	Low

Select the most suitable material (A-D) from the table above to be used for the support wires and justify your choice.

2

Choice of material _____

Reason for choice _____



12. A design for a child's secret diary is being developed. The design includes a keypad to enter a code to unlock the diary.



The logic circuit for the control of the lock is shown below.

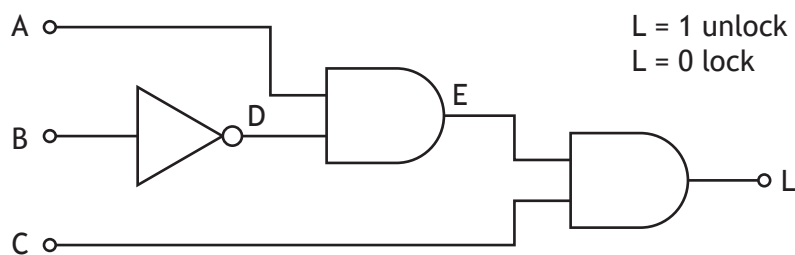

- (a) (i) Complete the Boolean equation, in terms of inputs A, B and C, for this logic circuit. 2

L = _____

- (ii) Complete the truth table for the logic circuit shown above. 3

A	B	C	D	E	L
0	0	0			
0	0	1			
0	1	0			
0	1	1			
1	0	0			
1	0	1			
1	1	0			
1	1	1			



12. (continued)

(b) An electronic engineer decides to use a microcontroller based system to operate the lock rather than a logic circuit.

- (i) Describe a **functional advantage** of using a microcontroller based system rather than a logic circuit to operate the lock.

1

- (ii) Explain why using a microcontroller based system, rather than a logic circuit, is better for the environment.

2



[Turn over for next question

DO NOT WRITE ON THIS PAGE



* X 8 2 3 7 5 0 1 1 7 *

13. A sailing catamaran is shown.



A simplified diagram showing the forces from the catamaran and crew is shown below.

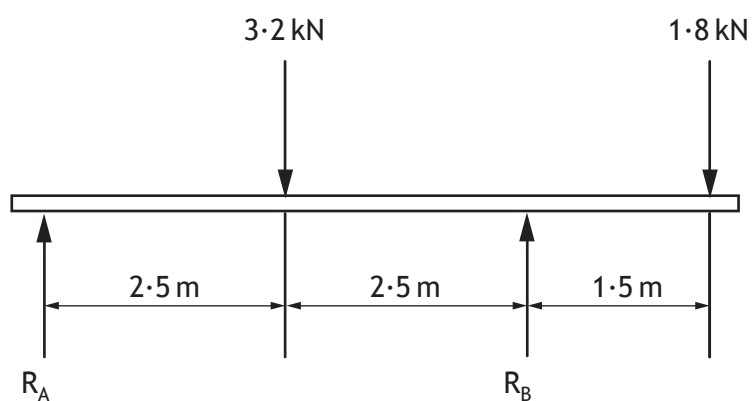

(a) (i) Calculate the size of reaction force R_A , by taking moments about R_B . 3

13. (a) (continued)

(ii) Calculate the size of reaction force R_B .

2

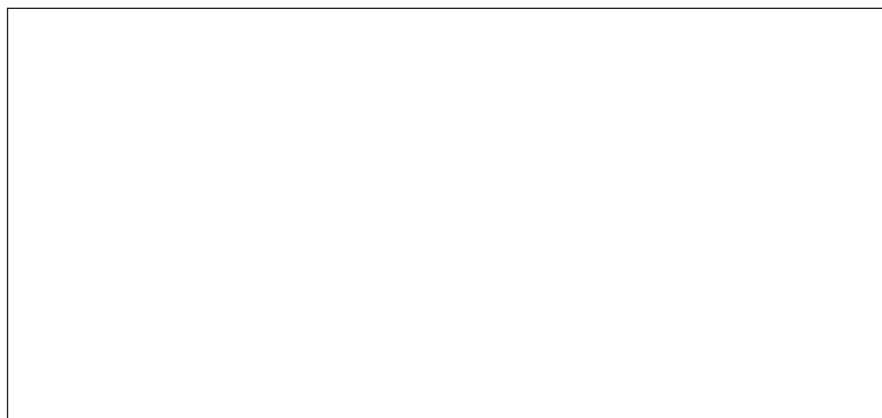

(b) Describe two specific roles a **structural** engineer may have had in the **development** of the catamaran.

2

1 _____

2 _____

[Turn over



* X 8 2 3 7 5 0 1 1 9 *

14. A desktop fan is shown.

MARKS
DO NOT
WRITE IN
THIS
MARGIN



A possible circuit used to control the operation of the fan's motor is shown below.

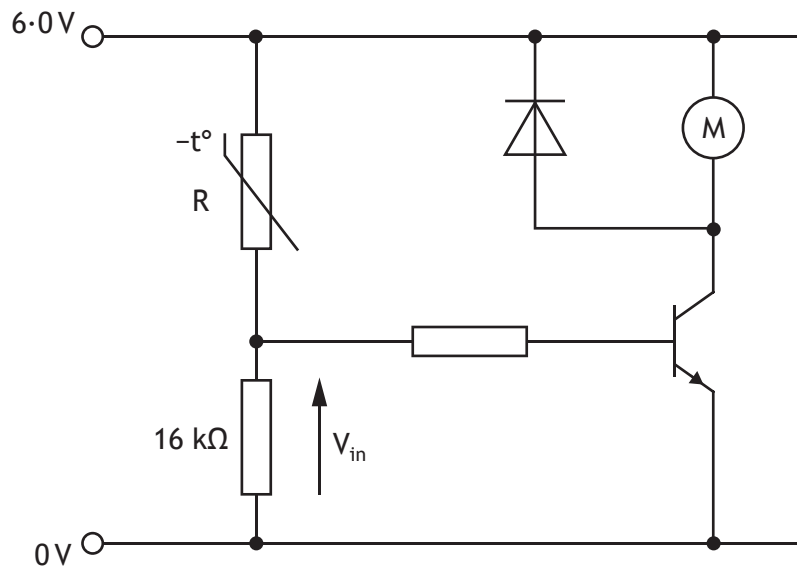

14. (continued)

- (a) Describe the operation of the circuit shown opposite, as the temperature in the room increases.

Include reference to the resistance of the thermistor and the voltage V_{in} .

As the temperature increases...

[Turn over



14. (continued)

The input sensing circuit of the fan is shown below.

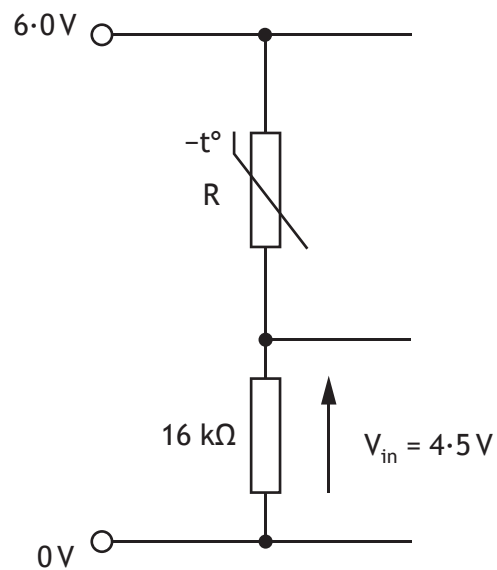

(b) Calculate the resistance R, when $V_{in} = 4.5\text{ V}$.

4

(c) Describe how the input sensing circuit could be modified so that the user can alter the temperature at which the fan motor switches on.

1



14. (continued)

- (d) Determine, with reference to the graph shown below, the resistance of a type 4 thermistor when the temperature is 25 °C.

1

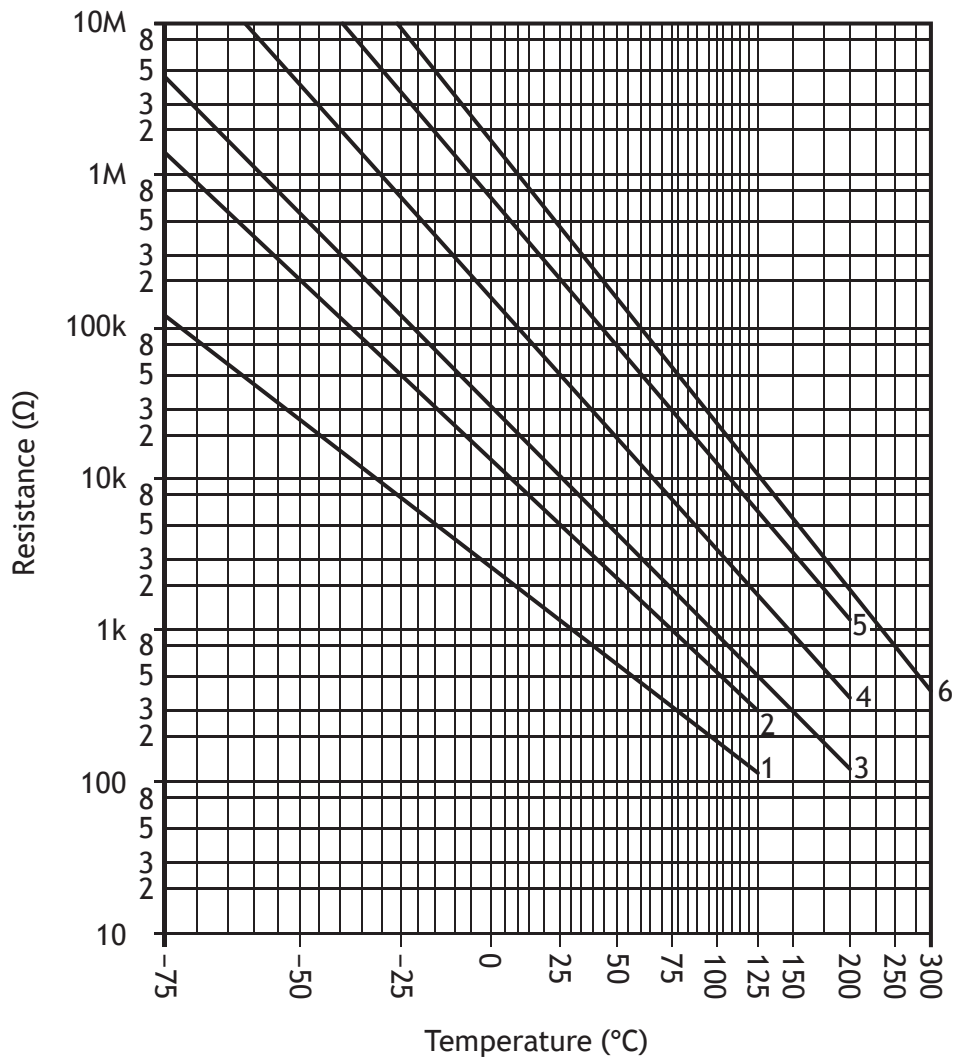

[Turn over



* X 8 2 3 7 5 0 1 2 3 *

14. (continued)

- (e) The base of the fan has a force of 25 N applied to it and a stress of 0.029 Nmm^{-2} .

Calculate the cross sectional area of the base of the fan.

3



[Turn over for next question

DO NOT WRITE ON THIS PAGE



* X 8 2 3 7 5 0 1 2 5 *

15. A food processing company uses an industrial mixing machine to combine pastry ingredients. A compound gear train which forms part of the mixing machine is shown below.

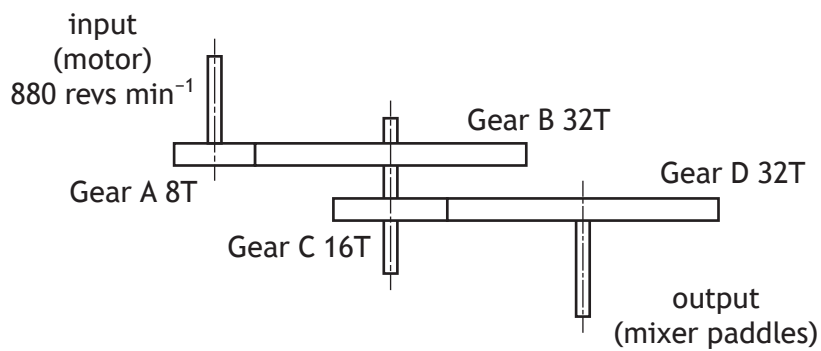

- (a) (i) Calculate the output speed of the mixer paddles.

4

- (ii) Calculate the velocity ratio of the compound gear train.

2



15. (continued)

- (b) During testing it was found that the mixing paddles were rotating too slowly.

Describe one change that could be made to Gear B in order to increase the speed of the mixing paddles.

1

[Turn over



* X 8 2 3 7 5 0 1 2 7 *

15. (continued)

Portions of the pastry travel along a conveyor belt where a pneumatic piston presses them into pie casings.

The pneumatic circuit shown below operates the piston when the pastry is sensed in position.

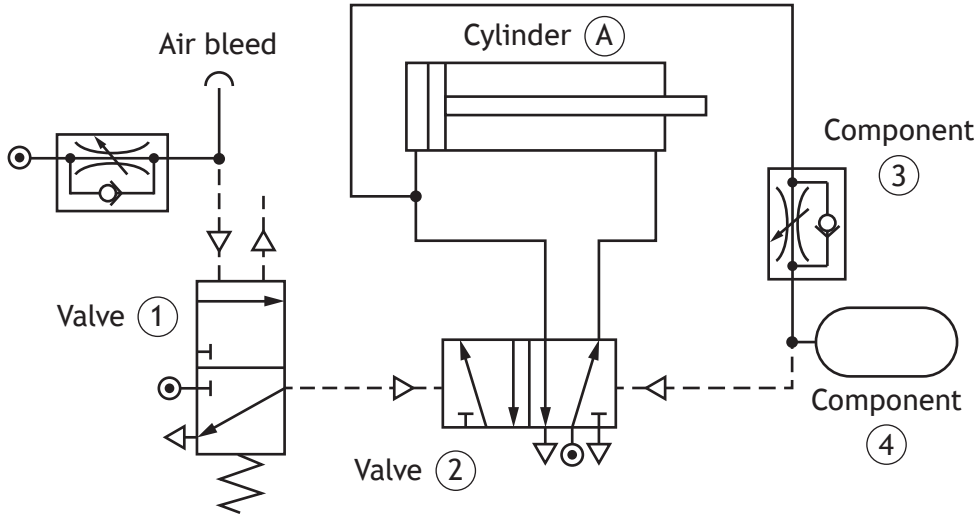

(c) Describe, using appropriate terminology, the operation of the pneumatic circuit, shown above.

3

When the air bleed is covered valve 1 is actuated.

15. (continued)

- (d) Explain why an air bleed was selected as an appropriate way of sensing the pastry.

2

- (e) The piston has a cross sectional area of 810 mm^2 and produces a force of 73 N.

Calculate the pressure supplied to outstroke the piston.

2

[Turn over



* X 8 2 3 7 5 0 1 2 9 *

16. Electric cars have been developed as an alternative to fossil fuel powered vehicles.



- (a) (i) Describe one **positive environmental** impact of using an electric car. 1

- (ii) Describe one **negative economic** impact of the increasing use of electric cars. 1



[Turn over for next question

DO NOT WRITE ON THIS PAGE



* X 8 2 3 7 5 0 1 3 1 *

16. (continued)

Part of a circuit used in an electric car is shown.

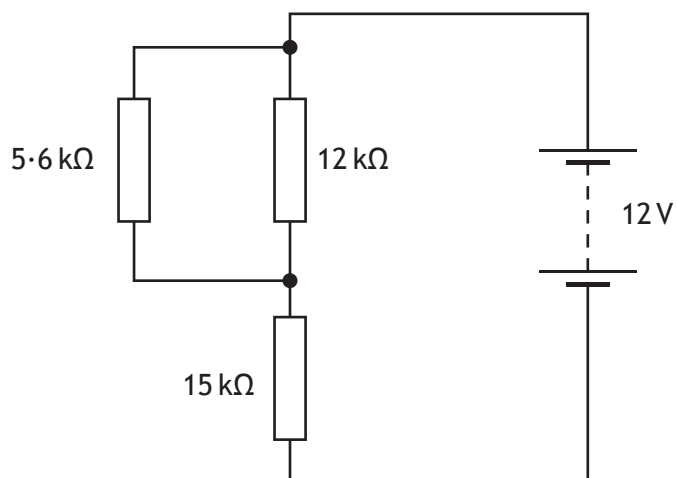

(b) Calculate the total resistance of this circuit.

3



* X 8 2 3 7 5 0 1 3 2 *

16. (continued)

- (c) (i) Calculate the voltage across the $15\text{ k}\Omega$ resistor when the current flowing through it is 0.6 mA .

2

- (ii) Calculate the current flowing through the $5.6\text{ k}\Omega$ resistor.

4

Electric vehicles are now considered to be an established technology. An **emerging technology** is one that has still to be tried commercially within a product or system.

- (d) Explain the possible impact of an **emerging technology** that you are familiar with.

2



17. A grilling machine is shown below.



The grilling machine has an input electrical energy of 1200 J. Only 790 J is transformed as useful output energy in the form of heat.

(a) Complete the energy audit diagram below for the grilling machine. Include details of the energy forms and their values.

3

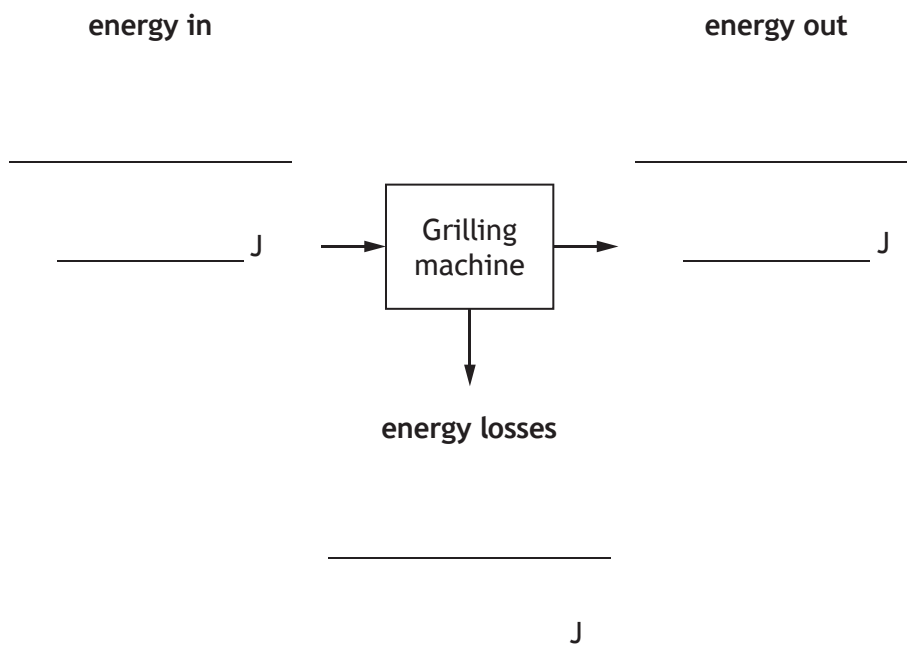

Space for rough working

17. (continued)

(b) Calculate the efficiency of the grilling machine.

2

(c) The grilling machine uses feedback to maintain a constant temperature.

(i) State the type of control that uses feedback.

1

(ii) Complete the sub-system diagram below for the grilling machine.

3

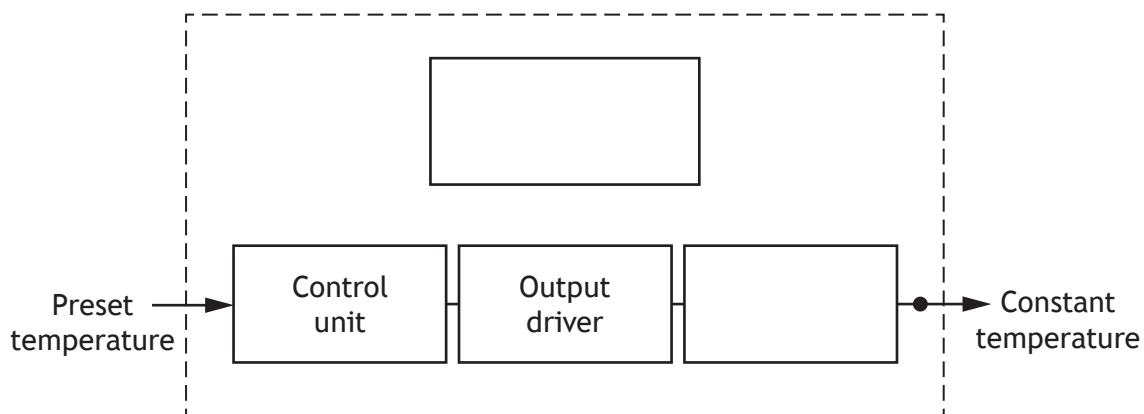

[Turn over for next question



* X 8 2 3 7 5 0 1 3 5 *

17. (continued)

(d) An upgrade to the grilling machine includes an LED to show when the required temperature has been reached.

(i) Draw the symbol for an LED in the position shown below.

2

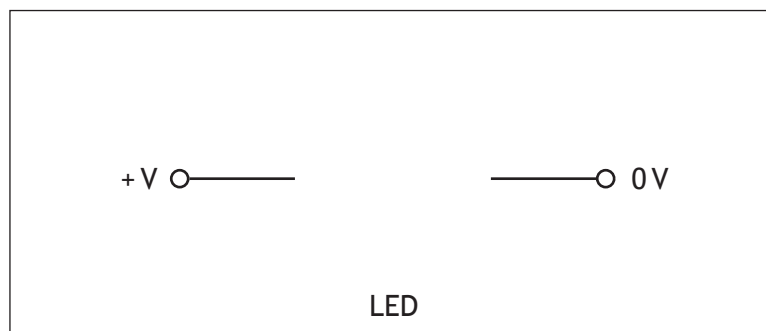

(ii) During testing of the circuit it was found that the LED was destroyed.

Describe one alteration that could be made to the circuit to prevent the LED from being destroyed.

1

[END OF QUESTION PAPER]

MARKS

DO NOT
WRITE IN
THIS
MARGIN

ADDITIONAL SPACE FOR ANSWERS



* X 8 2 3 7 5 0 1 3 7 *

MARKS

DO NOT
WRITE IN
THIS
MARGIN

ADDITIONAL SPACE FOR ANSWERS



* X 8 2 3 7 5 0 1 3 8 *

[BLANK PAGE]

DO NOT WRITE ON THIS PAGE



* X 8 2 3 7 5 0 1 3 9 *

ACKNOWLEDGEMENTS

Question 1 – Anastazi Li/Shutterstock.com

Question 3 – Sergiy Zavgorodny/Shutterstock.com

Question 11 – Byelikova Oksana/Shutterstock.com

Question 12 – nikiteev_konstantin/Shutterstock.com

Question 13 – Federico Rostagno/Shutterstock.com

Question 14 – ymgerman/Shutterstock.com

Question 16 – Nerthuz/Shutterstock.com

Question 17 – Ozgur Coskun/Shutterstock.com



* X 8 2 3 7 5 0 1 4 0 *